

UNIVERSAL CARRY HANDLE BARS

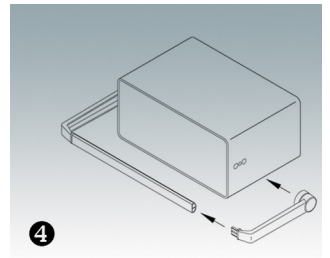

- Tilt and swivel carry handle bars/bail arms made of diecast zinc
- With matching aluminium profile, cut to the correct width for your enclosure, and supplied as a separate component.

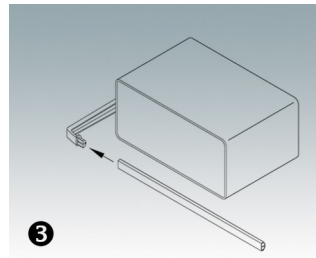
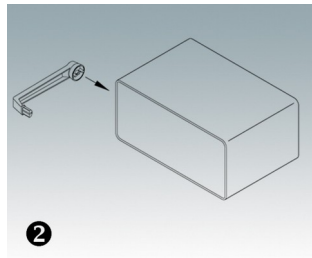
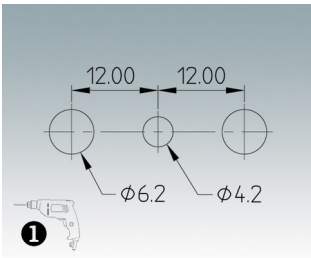
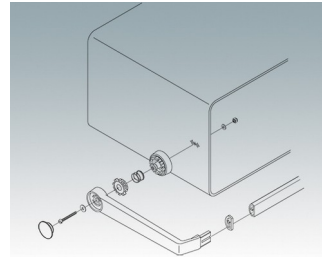
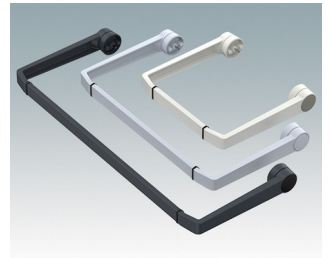
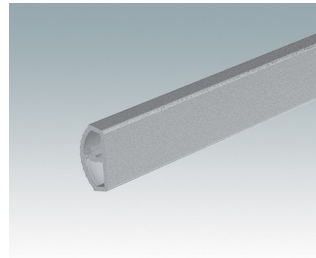
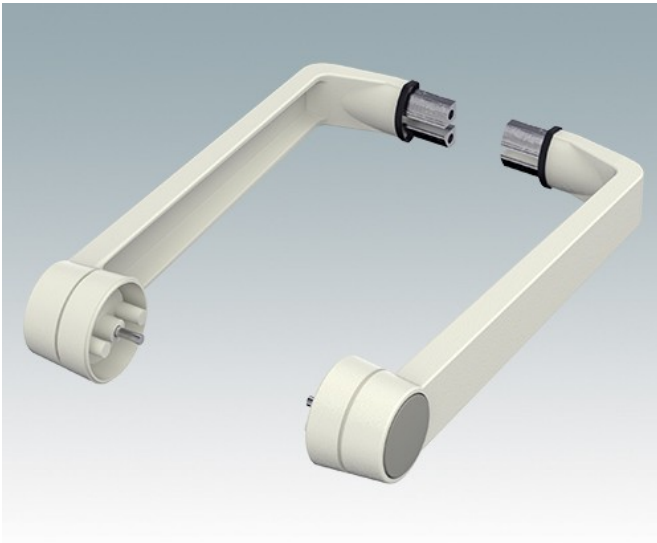

Select Versions

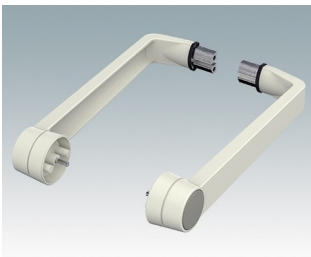

A9300014
Side arm kit
Zinc
Off-white RAL 9002



M5093004
Side arm kit
Zinc
Anthracite RAL 7016

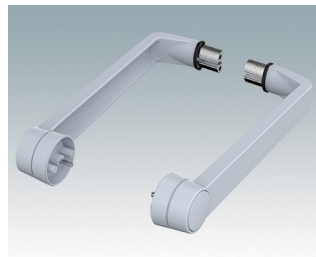

M5093005
Side arm kit
Zinc
Light grey RAL 7035



M5093009
Side arm kit
Zinc
Black RAL 9005

System components to complete

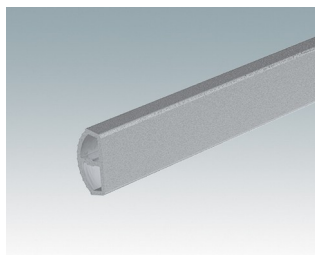

M50930-xxx
Handle profile, RAL 9006
Aluminium
Silver metallic RAL 9006

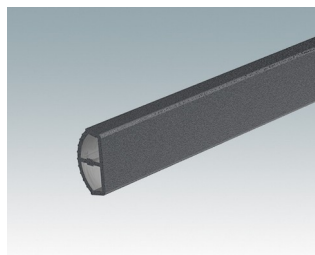

M50934-xxx
Handle profile, RAL 7016
Aluminium
Anthracite RAL 7016

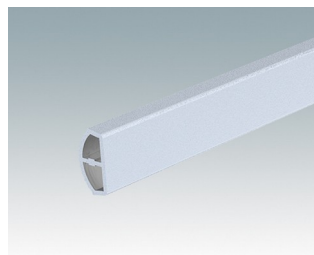

M50935-xxx
Handle profile, RAL 7035
Aluminium
Light grey RAL 7035

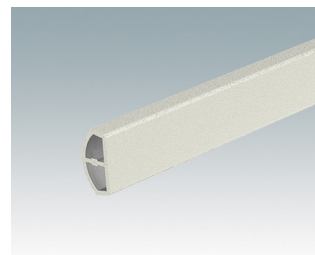

M50937-xxx
Handle profile, RAL 9002
Aluminium
Off-white RAL 9002

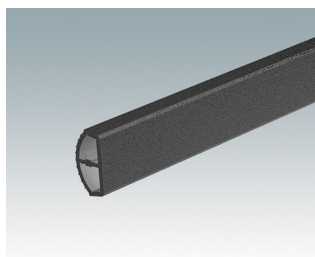

M50939-xxx
Handle profile, RAL 9005
Aluminium
Black RAL 9005

Subject to technical modification without notice. © OKW Enclosures Ltd